

# Smart Cassette Installation Instruction - Roller Shade

1. Cut all parts ( cassette, tube, fabric and bottom bar ) to the rightsize according to deduction sheet (Please refer to Smart Cassette Deduction Sheet for Roller Shade)

2. Attach fabric to tube.

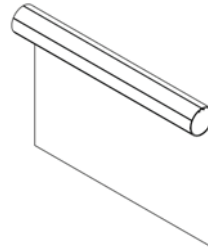

3. Install bottom bar onto fabric

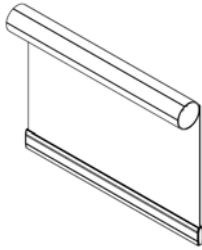

4. Place ball chain / cord into clutch.

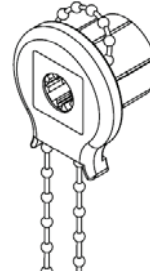

5. Insert clutch and idle end into blind.

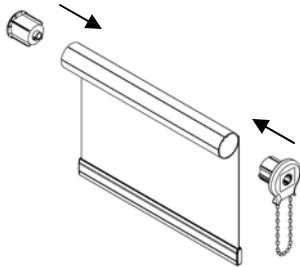

6. Insert idle end bracket into cassette housing.

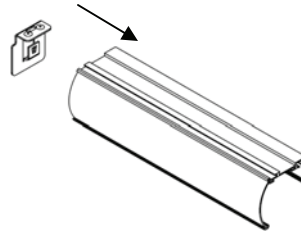

7. Insert idle end of pre-assembled roller shade into idle end bracket.

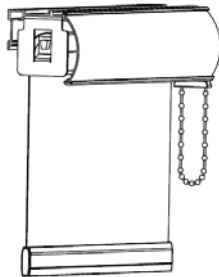

8. Insert clutch end bracket into cassette housing and clutch.

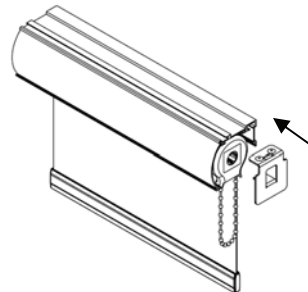

9. Put in end caps.

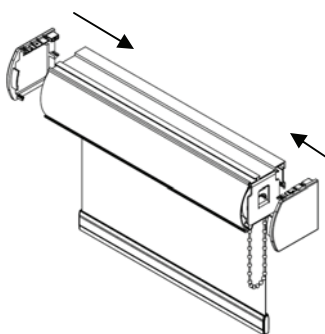

10. Drill one hole on each side of top cassette and insert plastic locking pins.

