

Fabric/Tube Deduction

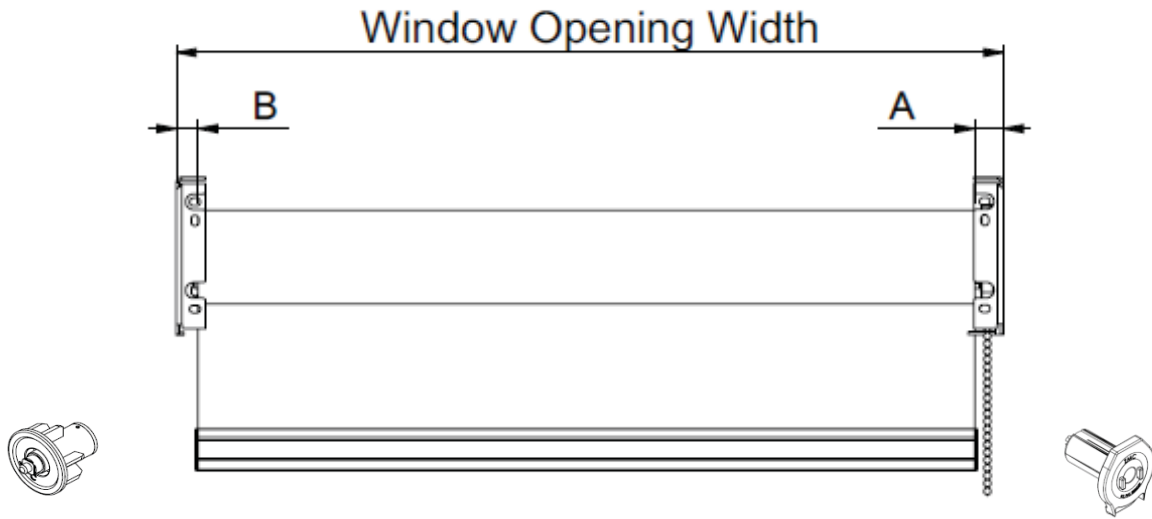







4"XL Fascia Bracket with XL20 Clutch

Single Band



Note:

1. Endcaps are not included in this drawing.
2. Endcap thickness is 1/8".

Tube	Clutch	Idler	A	B	Deduction (A+B)
1 1/2" Tube (RS- T46, RS- 2TU)  1 3/4" Tube (RS-3TU) 	XL 20 Clutch (XL-2R1/2X1/3X1) 	XL Idle End (XL-A01/B01/C01) 	19mm (3/4 ")	14.5mm (9/16 ")	33.5mm (1 5/16 ")
2" Tube (RS-T56) 	XL 20 Clutch for T46 (XL-2R1)  2" Adaptor (Z-10G/H) 	XL Idle End for T56 (XL-011) 	19mm (3/4 ")	13mm (1/2 ")	32mm (1 1/4 ")

Fabric/Tube Deduction





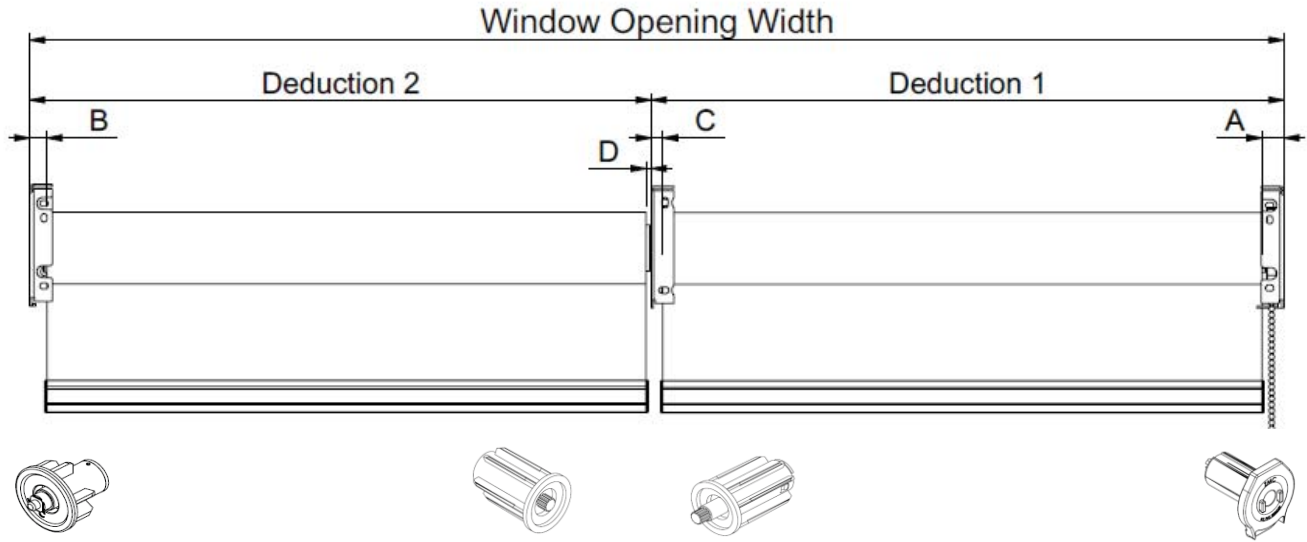



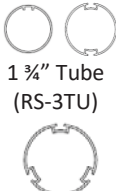

4"XL Fascia Bracket with XL20 Clutch

Multi Band-Intermediate



Note:

1. Endcaps are not included in this drawing.
2. Endcap thickness is 1/8".

Tube	Clutch	Inter. Idler	Idler	A	B	C	D	D1 (A+C)	D2 (B+D)
1 1/2" Tube (RS- T46, RS- 2TU)  1 3/4" Tube (RS-3TU) 	XL 20 Clutch (XL-2R1/2X1/3X1) 	Inter.Idler (RS-WQ5/1/2, RS-WM2/1/3) 	XL Idle End (XL-A01/B01/C01) 	19mm (3/4 ")	14.5mm (9/16 ")	9.5mm (3/8 ")	4.5mm (3/16 ")	28.5mm (1 1/8 ")	19mm (3/4 ")
2" Tube (RS-T56) 	XL 20 Clutch for T46 (XL-2R1)  2" Adaptor (Z-10G/H) 	Inter.Idler (RS-WM4) 	XL Idle End for T56 (XL-011) 	19mm (3/4 ")	13 mm (1/2 ")	9.5 mm (3/8 ")	4.5 mm (3/16 ")	28.5mm (1 1/8 ")	17.5mm (11/16 ")

Fabric/Tube Deduction





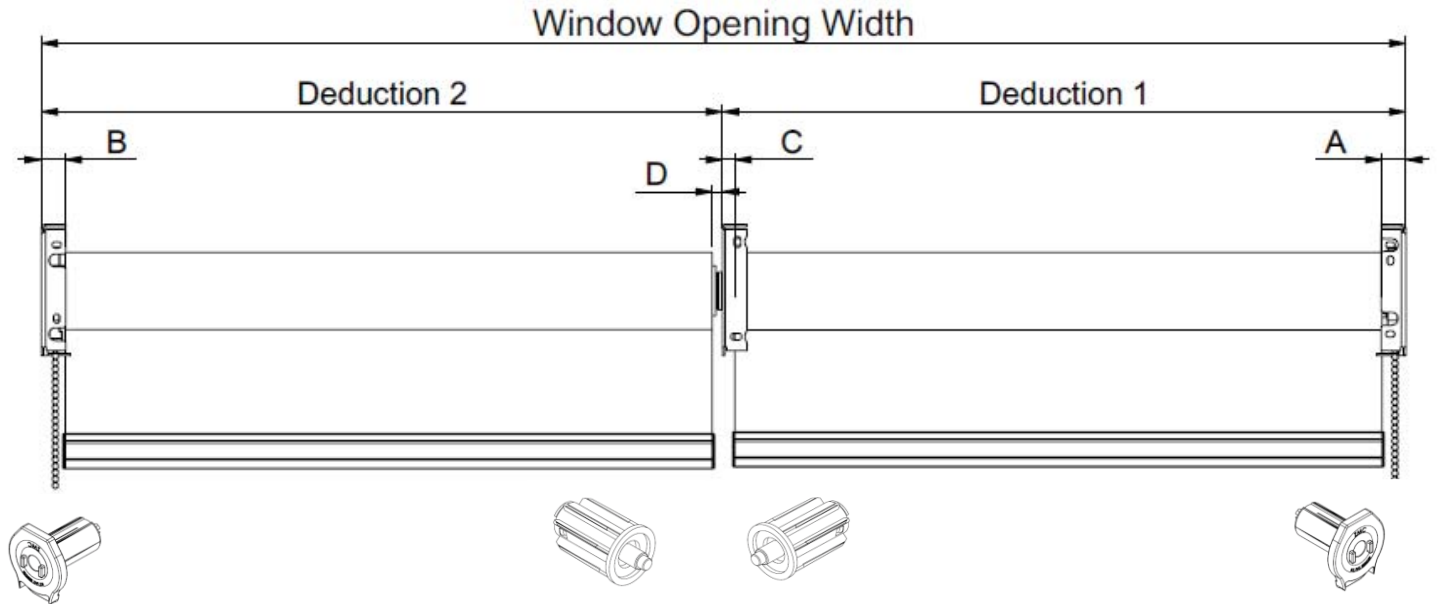



4"XL Fascia Bracket with XL20 Clutch

Multi Band-Center Support

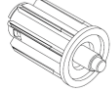

Note:

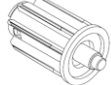
1. Endcaps are not included in this drawing.
2. Endcap thickness is 1/8".

Tube	Clutch	Center Idler	A	B	C	D	D1 (A+C)	D2 (B+D)
1 1/2" Tube (RS- T46, RS- 2TU)  1 3/4" Tube (RS-3TU) 	XL 20 Clutch (XL-2R1/2X1/3X1) 	Center Idler (RS-WQ6/3/4) 	19mm (3/4")	19mm (3/4")	9.5mm (3/8")	8mm (5/16")	28.5 mm (1 1/8")	27 mm (1 1/16")
2" Tube (RS-T56) 	XL 20 Clutch for T46 (XL-2R1)  2" Adaptor (Z-10G/H) 	Center Idler for T46 (RS-WQ6)  2" Adaptor (Z-10G/H) 	19mm (3/4")	19mm (3/4")	9.5mm (3/8")	8mm (5/16")	28.5 mm (1 1/8")	27 mm (1 1/16")