

Ensures shades roll up perfectly straight...

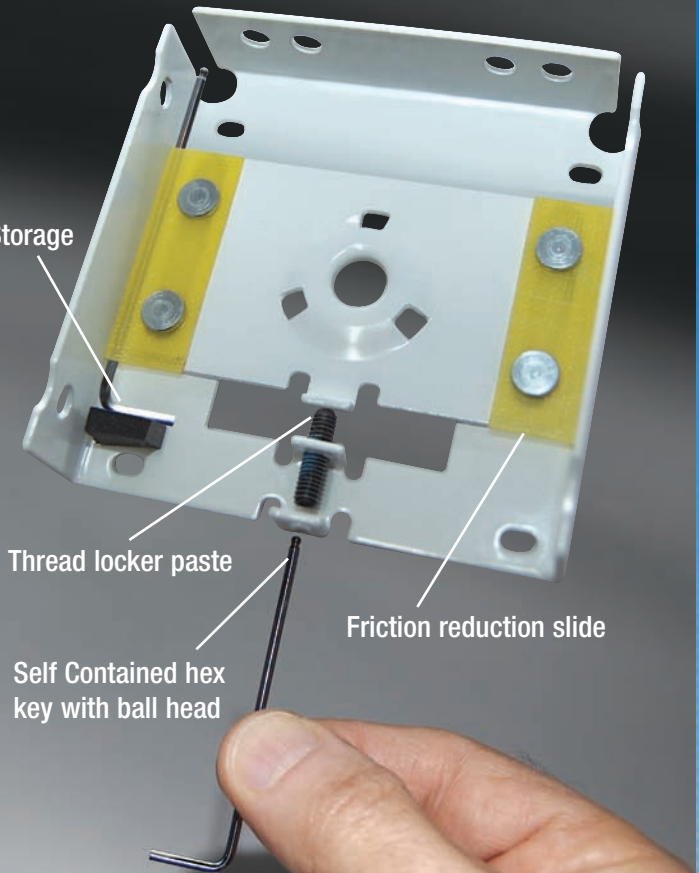

Hex Key Storage



Up to 6 mm precision adjustment.
Adjustable screw holds up to 60 lbs.

Features and Benefits

- ZMC's adjustable Fascia bracket is a convenient way of mounting a level roller shade even where the window frames are not true or perpendicular to the floor.
- The self contained "Allen key" design comes with a ball head that gives you the added flexibility of reaching the adjustable screw once the brackets are installed.
- The "Thread Locker Paste" holds the screw firmly in place but still allows for up and down adjustment.

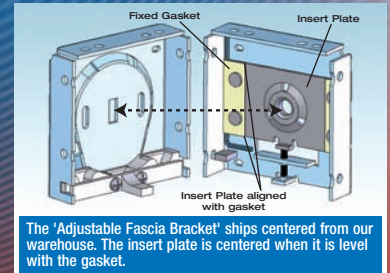

Available for various clutch idle ends

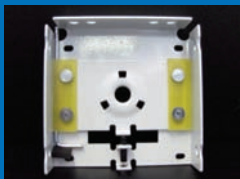

RS Idle end

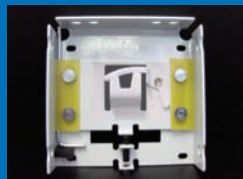

Z Clutch Idle end

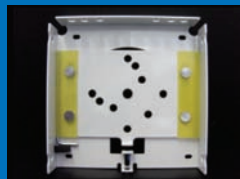

Somfy Idle end

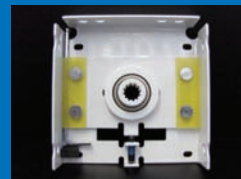

Intermediate Idle end

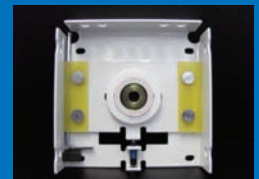

Center support Idle end

COLORS



White

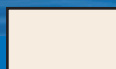

Alabaster

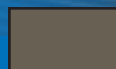

Bronze

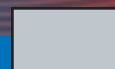

Anodized



Black

PATENT PENDING

For more information please contact us at:

Tel: 1.905.856.3838 or 1.800.541.2557

Fax: 1.905.856.3388

Website: www.zmc.ca

Email: contact@zmc.ca

Adjustable Fascia Brackets

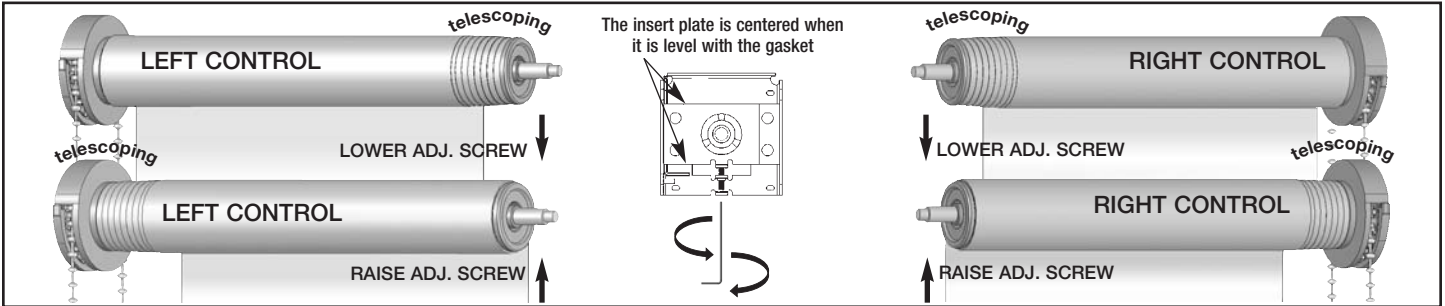

FOR RS-CLUTCH

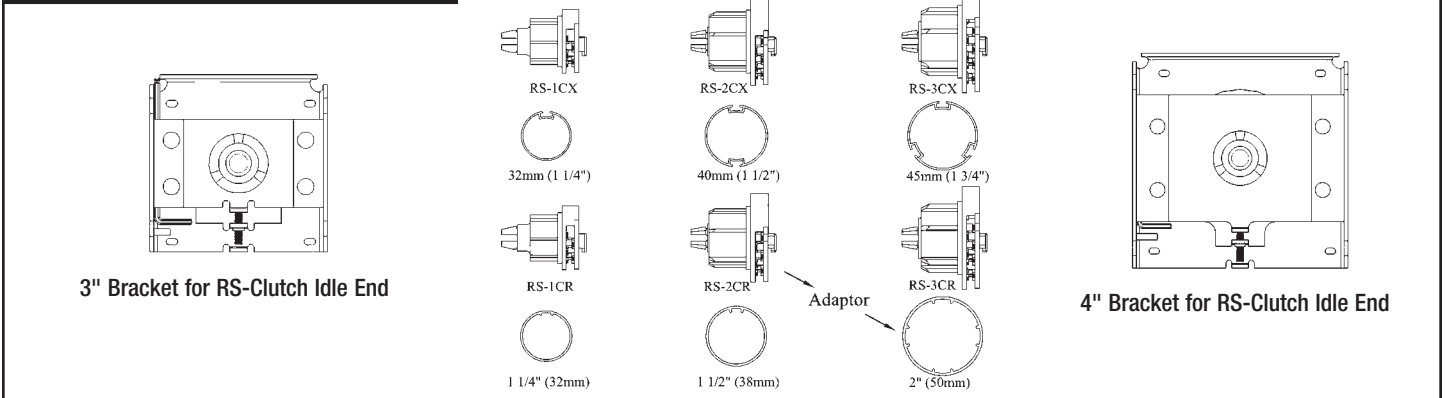

FOR SOMFY MOTOR

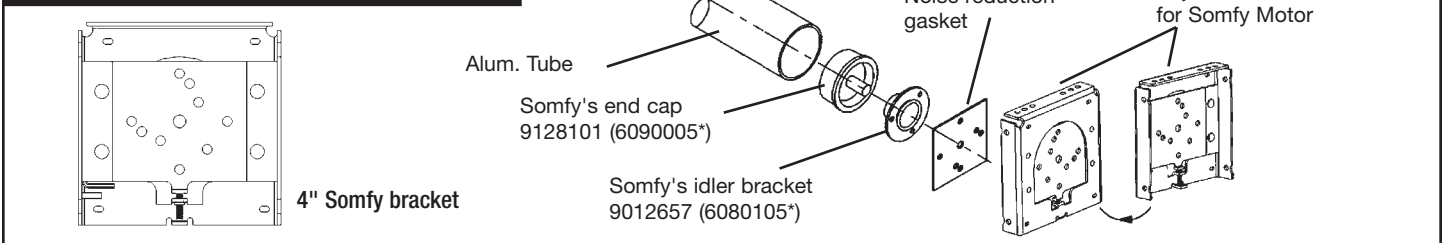

FOR Z-CLUTCH

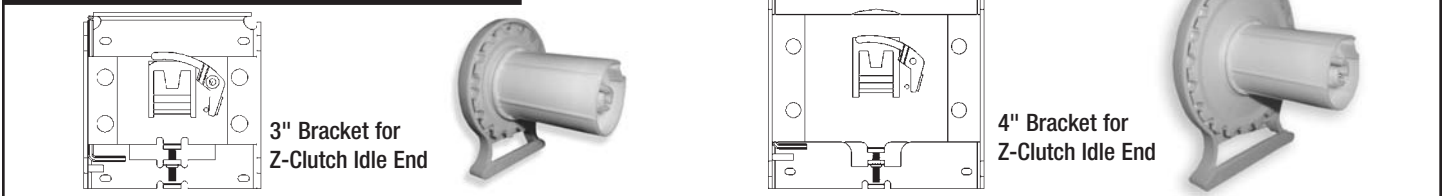

FOR INTERMEDIATE AND CENTER SUPPORT

